

Bio-Haz Vacuum

Model: C82917-00
C82917-02

OPERATION

SERVICE

PARTS

CARE

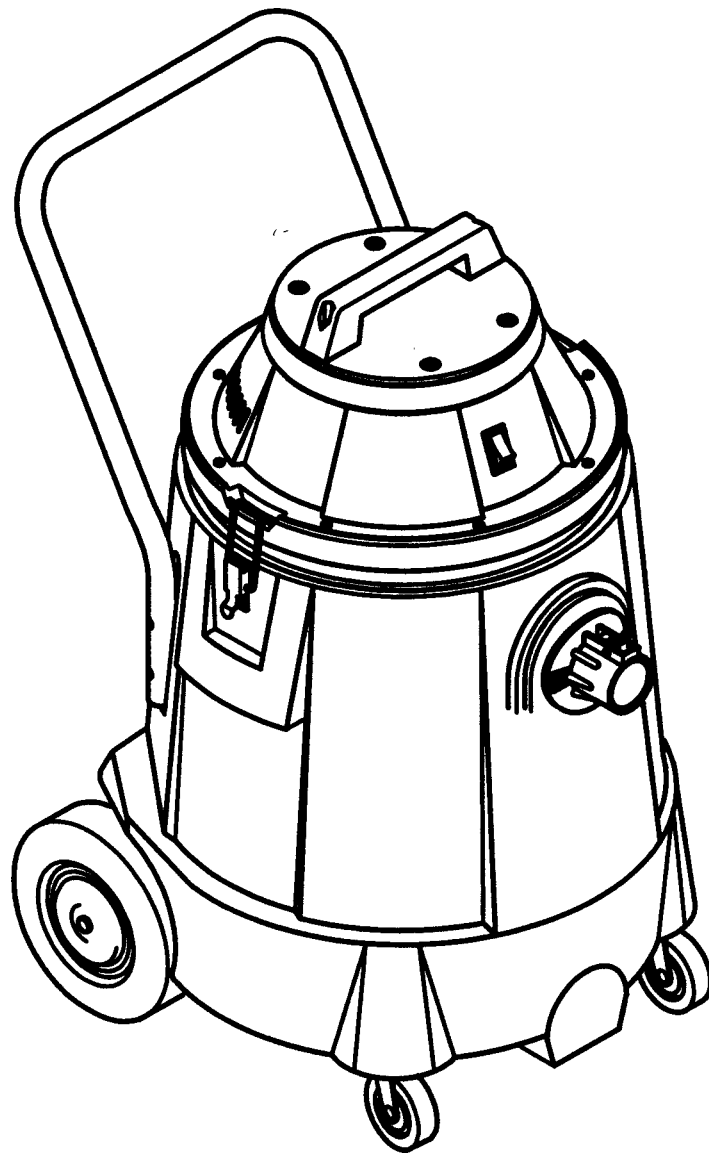

Revised 6/02

Minuteman[®]

EC Declaration of Conformity

according to Directives 72/23, 89/392, and 89/336

We, Minuteman International Incorporated, of 111 South Rohlwing Road Addison Illinois 60101 USA, declare under our sole responsibility that the product C82907-02 & C82917-02 a Critical Filter Vacuum to which this declaration relates corresponds to the relevant requirements of the EC Directives 72/23, 89/392 and 89/336. The following standards were used to determine compliance with the Directives: EN 292, EN 294, EN 811, EN 55014, EN 55104 and EN 60335-1.

SOUND		VIBRATION									
75 dB Operator	71dB At 3m	.5 m/s² At Operators Handle									
<p>Tests were conducted on 09/18/00 with calibrated sound and vibration equipment under the conditions noted below:</p> <table style="width: 100%; border: none;"> <tr> <td style="width: 33%;">General Condition: Indoors</td> <td style="width: 33%;">Wind: 0 km/hr</td> <td style="width: 33%;"></td> </tr> <tr> <td>Temperature: 25°C</td> <td>Humidity: 70%</td> <td></td> </tr> <tr> <td>Barometric Pressure: 29.5</td> <td></td> <td></td> </tr> </table>			General Condition: Indoors	Wind: 0 km/hr		Temperature: 25°C	Humidity: 70%		Barometric Pressure: 29.5		
General Condition: Indoors	Wind: 0 km/hr										
Temperature: 25°C	Humidity: 70%										
Barometric Pressure: 29.5											

Jeff Pollack

Jeff Pollack, Standards Engineer

10/24/01

Date

FOR COMMERCIAL USE ONLY

IMPORTANT SAFETY INSTRUCTIONS

When using an electrical appliance, basic precautions should always be followed, including the following:

READ ALL INSTRUCTIONS BEFORE USING

DANGER! - THIS VACUUM IS FOR PICK UP OF PARTICULATE MATERIAL ONLY.
NOT FOR VAPOR RECOVERY.

WARNING - To reduce the risk of fire, electric shock, or injury:

- Do not return to manufacturer for repair.
- Do not leave appliance when plugged in. Unplug from outlet when not in use and before servicing.

WARNING

To reduce the risk of electric shock - Do not expose to rain. Store indoors.

- Do not allow to be used as a toy. Close attention is necessary when used by or near children.
- Use only as described in this manual. Use only manufacturer's recommended attachments.
- Do not use with damaged cord or plug. If appliance is not working as it should, has been dropped, damaged, left outdoors, or dropped into water, return it to a service center.
- Do not pull or carry by cord, use cord as a handle, close a door on cord, or pull cord around sharp edges or corners. Do not run appliance over cord. Keep cord away from heated surfaces.
- Do not unplug by pulling on cord. To unplug, grasp the plug, not the cord.
- Do not handle plug or appliance with wet hands.
- Do not put any object into openings. Do not use with any opening blocked; keep free of dust, lint, hair, and anything that may reduce air flow.
- Keep hair, loose clothing, fingers, and all parts of body away from openings and moving parts.
- Do not pick up anything that is burning or smoking, such as cigarettes, matches, or hot ashes.
- Do not use without dustbag and/or filters in place.
- Turn off all controls before unplugging.
- Use extra care when cleaning on stairs.
- Do not use to pick up flammable or combustible liquids such as gasoline or use in areas they may be present.
- Connect to a properly grounded outlet only. See grounding instructions.

SAVE THESE INSTRUCTIONS

INSPECTION

Carefully unpack and inspect your machine for shipping damage. Each unit is tested and thoroughly inspected before shipment, and any damage is the responsibility of the delivery carrier who should be notified immediately.

ELECTRICAL - 115 Volt

This machine is designed to operate on a standard 15 amp. 115 volt, 60 hz, AC circuit. Voltages below 105 volts AC or above 125 volts AC could cause serious damage to the motor.

ELECTRICAL - 240 Volt

This machine is designed to operate in a standard 10 amp. 230 volt, 50 hz, AC circuit.

WARNING

Electric motors can cause explosions when operated near explosive materials or vapors. Do not operate this machine near flammable materials such as solvents, thinners, fuels, grain dust, etc.

GROUNDING INSTRUCTIONS

This appliance must be grounded. If it should malfunction or breakdown, grounding provides a path of least resistance for electric current to reduce the risk of electric shock. This appliance is equipped with a cord having an equipment-grounding conductor and grounding plug. The plug must be plugged into an appropriate outlet that is properly installed and grounded in accordance with all local codes and ordinances.

DANGER

Improper connection of the equipment-grounding conductor can result in a risk of electric shock. Check with a qualified electrician or service person if you are in doubt as to whether the outlet is properly grounded. Do not modify the plug provided with the appliance — if it will not fit the outlet, have a proper outlet installed by a qualified electrician.

This machine is for use on a nominal 120 volt circuit and has a grounding plug that looks like the plug illustrated in Sketch A. Make sure that the machine is connected to an outlet having the same configuration as the plug. No adapter should be used with this appliance.

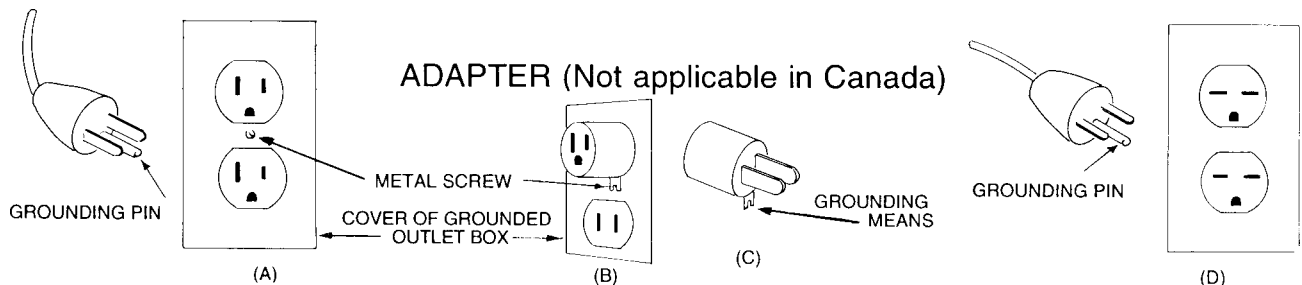

USER MAINTENANCE INSTRUCTIONS

All service and repair should be performed by qualified vacuum service representative or electrician. No user serviceable components are employed in the electrical vacuum lid head assembly. No lubrication of the motor is required.

WARNING

This vacuum may contain potentially hazardous dust depending on its application. Special handling of contaminated disposable bags and filters is recommended. Disposal must be in compliance with local EPA regulations.

The use of this machine in conjunction with the pick-up of hazardous materials has not been investigated by U.L.

CLOTH BAG & HOSE ASSEMBLY

Cloth bag and hose assembly are user maintenance items and can be replaced when worn out. Cloth bags can be maintained by blowing dust off of the bag and then laundered. Cloth bags should be completely dried before re-installing into machine. For optimum performance, empty and clean filter bag regularly. A clogged and dirty bag restricts the flow of air and results in reduced vacuum. The hose assembly can be maintained by wiping off with a dampened cloth of mild liquid soap and water, then allowed to dry.

CORD STORAGE

While not in use storage can be accomplished by winding cord around motor lid assembly. Cord should be completely unwound from lid assembly during operation.

- Do not use with damaged cord or plug. If appliance is not working as it should, has been dropped, damaged, left outdoors, or dropped into water, return to service center.
- Do not pull or carry by cord, use cord as handle, close a door on cord, or pull cord around sharp edges or corners. Do not run appliance over cord. Keep cord away from heated surfaces.
- Do not unplug by pulling cord. To unplug, grasp the plug, not the cord.
- Do not handle plug or appliance with wet hands.

Always unplug the machine when removing the motor head off the tank. This equipment should be stored indoors and not exposed to rain.

OPERATION AND FILTER CARE INSTRUCTIONS

The Minuteman Bio-Haz Vacuum has been specifically designed to clean up hazardous dust of all types. Special filters reduce the incidence of airborne dust that would be created by any other method of cleaning.

During the removal of hazardous dust, do not sweep, scoop, shovel, or in any manner handle other than by vacuuming.

Do not at any time attempt to bypass, remove, substitute or by any other means change the filters used in this vacuum.

Use only approved Minuteman Bio-Haz Vacuum filters and filter bags.

Before attempting to use and before cleaning, be certain that you fully understand the instructions given for the setting up or cleaning/changing of filters of this vacuum.

Each facility has its own individual and unique cleaning problems, it is suggested that you use the following:

TANK/FILTER SET-UP PROCEDURE

Refer to Page 6

1. Fully open the plastic bag and place it down into the tank; #6 on the underside of the intake tube as shown.
2. Take the paper bag that has the cardboard collar attached and open it up by gently pulling the folds apart.
3. You will notice two creases on the top side of the collar; carefully bend the ends down (toward) the bag.
4. Insert this bag into the tank and push it to the bottom, taking care not to snag the plastic bag.
5. Locate the cardboard collar around the intake tube and gently work it up past the raised ring that runs around the tube.
6. Push the plastic bag down past the paper bag; position it about 1/2 to 2/3 down past the top of the bag.
7. Starting at the bottom of the cloth filter, slip the paper filter protector over the entire cloth filter until the elastic band on the paper filter protector goes around the black plastic frame of the cloth filter.
8. Ensure that the inside steel frame that supports the cloth filter is inserted into the tank with the cut out section facing the front of the down tube. Then insert the cloth filter and paper filter protector inside the tank. Be careful not to rip the paper filter protector when pushing the cloth filter with steel frame into the tank.
9. Position the lid onto the tank, making sure that the paper filter elastic is inside the cloth filter frame so that the H.E.P.A. or U.L.P.A. filter will go down inside the cloth filter. Make sure that the motor lid is seated onto the ring of the cloth filter frame completely around the tank.
10. Snap the lid latches into place.

For proper cleaning of the tank and removal/changing of the filters, see **“Procedures in Removing Contaminated Filters and Cleaning of Contaminated Tank.”**

PROCEDURES IN REMOVING CONTAMINATED FILTERS AND CLEANING OF CONTAMINATED TANK

Always wear a facemask and gloves when conducting this procedure.

1. Unplug the machine from the power source.
2. Carefully and slowly unlatch the tank latches and remove the vacuum lid only (be sure when you lift up on the lid that the cloth filter stays inside the tank.) Set the lid with either a H.E.P.A. or U.L.P.A. filter assembly aside.
3. Gently remove the cloth and paper filter protector from the tank. Carefully place the paper and cloth filter into a plastic bag. With one hand grab the bottom of the paper filter protector through the plastic bag and with the other hand release the elastic band from around the cloth filter frame. Slide the cloth filter out of the paper bag. Set the cloth filter and frame aside.
4. Before closing up the plastic bag with the used paper filter inside, check the impact filter attached to the H.E.P.A. or U.L.P.A. filter for any noticeable dirt. The impact filter should be changed every other time you change the paper filter or if any dirt particles are noticed during inspection. Then the used impact filter can also be put into the plastic bag before sealing up for disposal. See **“Changing the Pink Impaction Filter”**, on page 5, for more information.
5. Carefully surround the paper debris bag with the plastic bag in the bottom of the tank. Pull the opening of the plastic bag securely around the down tube with one hand. This plastic bag will completely encapsulate the debris bag. Push downward on the debris bag on the debris bag’s cardboard collar until it slips off of the downtube.
6. Slowly pull the top of the plastic bag upwards. When you have the plastic bag fully extended upwards, slowly squeeze the plastic bag closed to avoid trapping excess air. Twist the plastic bag until enough plastic can be tied into a knot.
7. Lift the bag out of the tank and dispose of it properly.

(Continued on next page)

(Cont'd) PROCEDURES IN REMOVING CONTAMINATED FILTERS AND CLEANING OF CONTAMINATED TANK

8. Before inserting another plastic bag and paper debris bag, take a wet paper towel and wipe out the inside of the tank of any dirt contaminate. Put this inside the plastic bag along with the used paper filter protector and impact filter. This plastic bag should also be twisted shut, tied into a knot and disposed of properly.
9. To help prolong the life of the H.E.P.A. or U.L.P.A. filter, a spare cloth filter should be interchanged with the existing cloth filter. Vacuum out when there is any noticeable dirt or soil. The cloth bag can also be sprayed with a garden hose from the inside out to remove any soil. Make sure that the cloth filter is completely dry before reinstalling it into the vacuum.
10. CAUTION: Any hazardous materials must be disposed of properly. Never throw contaminated debris into you usual trash receptacle. Place debris in a plastic bag or can marked "Hazardous Materials" and take to a hazardous waste handler.
11. For proper assembly of new filters, see "**Tank Filter Set Up Procedures.**", on page 4.

CHANGING THE PINK IMPACTION PREFILTER

The pink impaction filter should be changed, using all of the precautions previously mentioned. The impaction filter should be changed when any of the following takes place:

1. Anytime there is an indication of a filter tear during normal operation of the unit. This tear could be in any of the filters used.
 - a. paper dust containment bag
 - b. paper bag protector
 - c. cloth filter bagThese tears would show up during the tank clean-out procedure, or...
2. Every other tank clean-out period. To change the impaction filter, do the following before you do Step #3 of the normal clean-out procedure.
 - a. Wipe down all of the exposed surfaces on the underside of the removed lid, using the dampened wiping cloth.
 - b. Carefully unclamp filter retainer from the side of the filter. Set the retainer aside.
 - c. Remove the impact filter from the high efficiency filter. Be careful so as not to damage or puncture the U.L.P.A. or H.E.P.A. media used in the final filter. Do not attempt to clean the pink impact filter in any way; dispose of by placing it into the tank you are now in the process of cleaning. **DO NOT USE ANY TOOLS TO REMOVE THE IMPACT FILTER.**
 - d. Before proceeding any further in cleaning the tank, first place a new impact filter (one only) onto the H.E.P.A. or U.L.P.A. filter. Replace the impact retainer and lock it into place by reclamping.

1. 829124 Lid Assembly Complete 115V
829224 Lid Assembly Complete 240V
2. 110004 H.E.P.A. or 110007 U.L.P.A. Filter
3. 110005 Impact Filter
4. 805058 Cloth Bag Complete
5. 805038PKG Disposable Paper Filter Protector (12)
6. 829000-1 Tank Assembly Complete 15 Gallon
7. 760598PKG Disposable Paper Bag (10)
8. 802215PKG Plastic Bag (10/pkg)

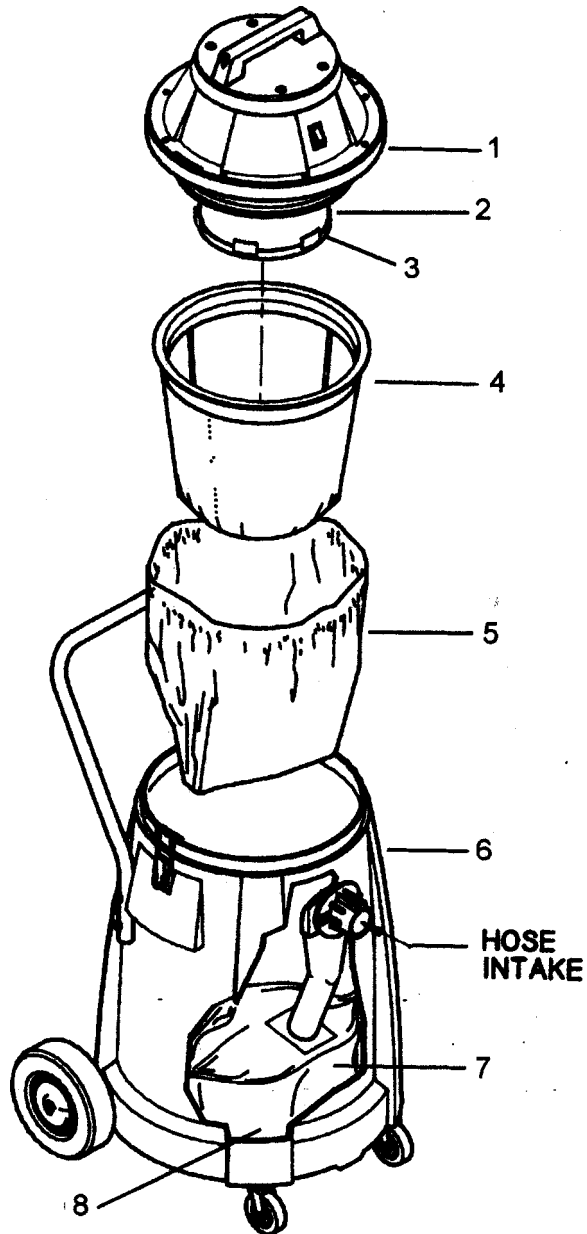

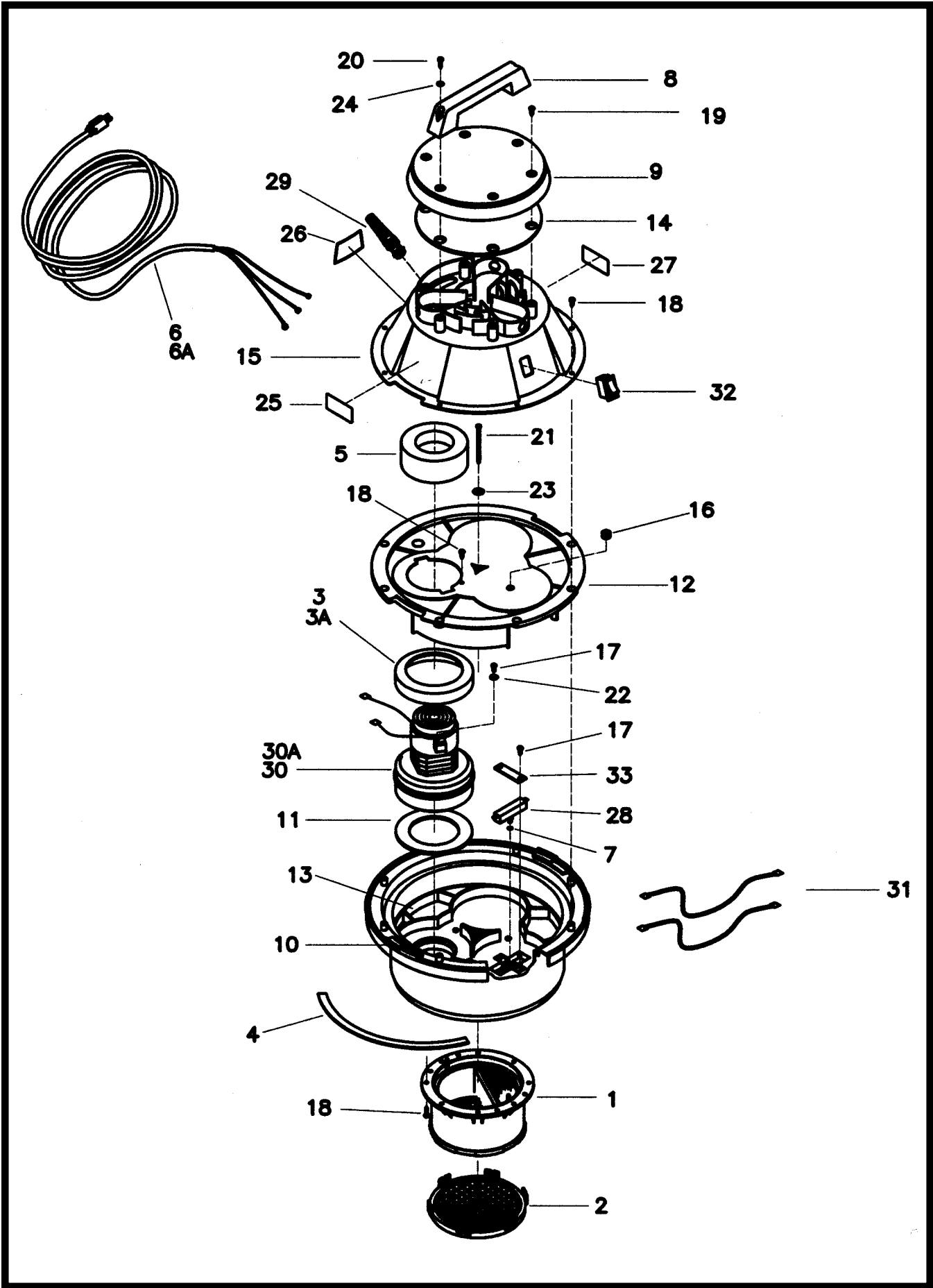

PARTS LIST

Item	Part No.	Qty.	Description
1	110007	1	ULPA Filter
2	110005	1	Pre-Filter Snap-On
3	290017	1	Molded Gasket 120V
3A	380035	1	Gasket Diecut 240V
4	290030	1	Lid Gasket Diecut
5	380064	1	Ring, Foam
6	381020	1	Med. Grey Cord Set 16-3 50"
6A	740600	1	Cord HO5 VVF3G1.5 x 50'
7	390062	1	O Ring Valve Seat Body
8	460000	1	Handle Lid
9	460003	1	Lid Cover
10	460010	1	Vacuum Housing
11	460019	1	Gasket 3.75 x 5.75 x .75
12	460031-A	1	Motor Holdown Single HEPA
13	460032-A	1	Vac Motor Adapter w/HEPA
14	460045	1	Dome Seal Gasket
15	460070	1	Motor Cover Single
16	700287	1	Grommet
17	711124	3	SCR-ST-B 10 x .37 NI
18	711160	19	SCR Hi/Lo #10 x 5/8 PL
19	711161	4	SCR Hi/Lo #10 x 3/4 PL
20	711162	2	SCR Hi/Lo #10 x 1 1/2 PL
21	711170	1	SCR #10 A Point x 3.5
22	711553	1	WSR-Internal Lock #10
23	711584	1	WSR-Finish #10
24	712320	2	WSR-Nylon .22 x .45 x .04
25	715058	1	Decal Caution UL Hazardous
26	715115	1	Decal Warning PV Dry
27	715531	1	Decal, Danger
28	740029	1	Switch 1.5 HP
29	733237	1	Strain Relief w/Nut
30	740357	1	Vac Motor 120V
30A	740149	1	Vac Motor 240V
31	740416	2	Wire Assembly 14 GA Black
32	809754	1	Switch Rocker
33	829196	1	Mounting Bracket Switch
***	829124	1	Lid Assembly Complete 120V
***	829224	1	Lid Assembly Complete 240V

Ref Item 11 Pre-Filter

To install pre-filter item 2, position on bottom of critical filter item 1 or 1A as shown on page 7 and snap into place. To remove, rotate pre-filter on base of critical filter to disengage clamp fingers and slide off.

WARNING



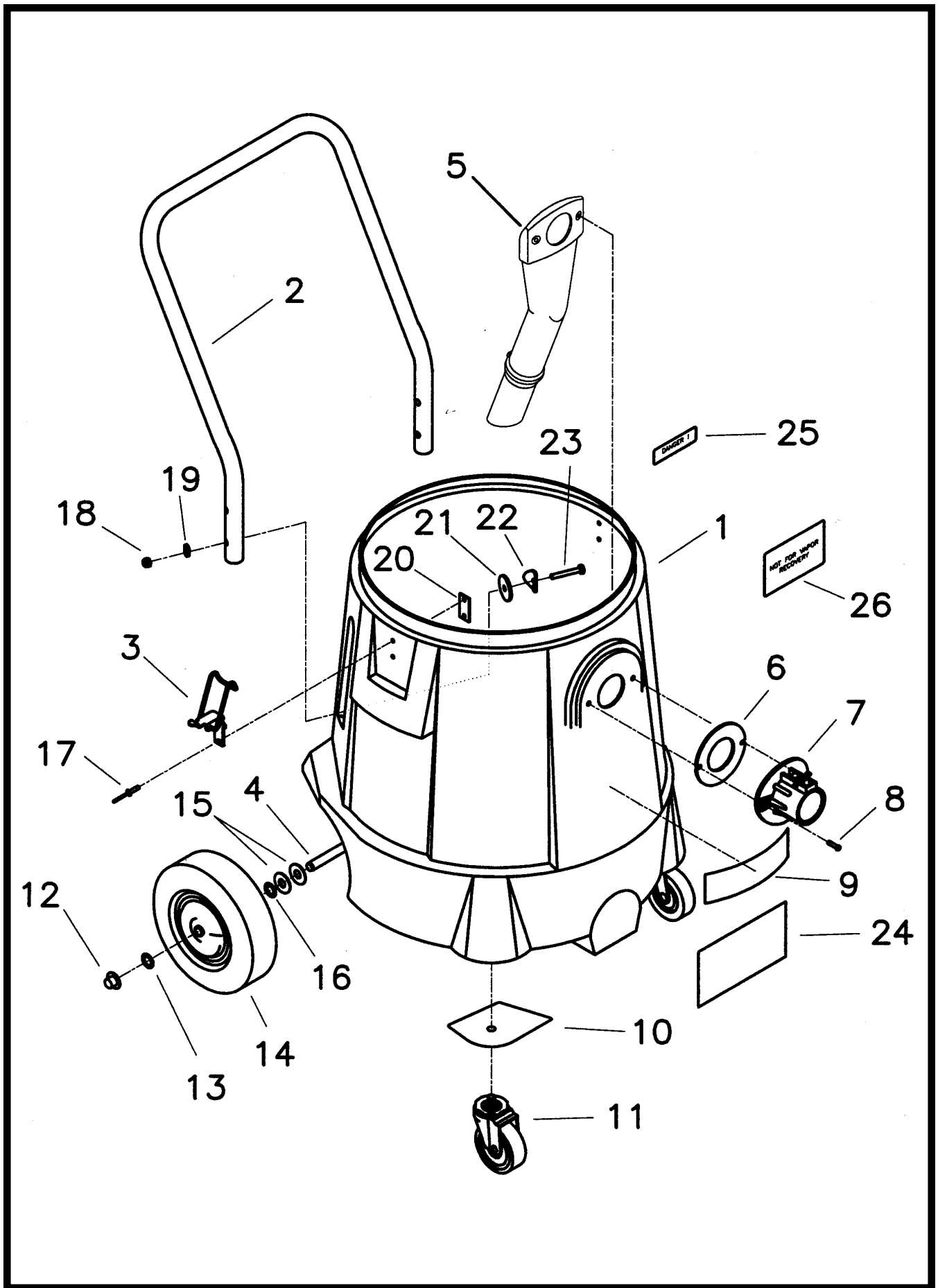





This vacuum may contain potentially hazardous dust depending on its application. Special handling of contaminated disposal bags and filters is recommended. Disposal must be in compliance with local regulations.

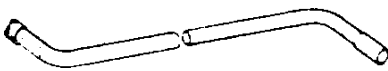

PARTS LIST

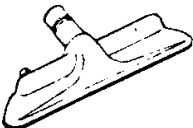
Item	Part No.	Qty.	Description
1	390018	1	Tank 15 Gallon Burgundy
2	390031	1	Handle
3	390035	2	Latch
4	390011	1	Axle
5	390016	1	Downtube
6	390087	1	Gasket Diecut
7	390110	1	Intake Assembly
8	712532	2	SCR-MC 10-24 x 1.00 SS
9	715383	1	Decal Minuteman
10	280017PLT	2	Backing Plate
11	280016	2	Caster 3"
12	130032	2	Retainer Cap
13	711594	2	WSR-Flat .56 x .88 x .03
14	900008	2	Wheel 8"
15	711518	4	WSR-Flat 1/2
16	711524	2	WSR-Wave .52 x .87 x .01
17	828984	4	Pop Rivet
18	711352	4	Nut-Acorn 1/4-20
19	711444PLT	4	1/4-20 Weldnut Plated
20	833831	2	Clamp Back Plate
21	828980	4	Gasket
22	712766	4	WSR-Special Curved
23	712541	4	SCR-THMS 1/4-20 x 1.0 SS
24	715452	1	Decal, Filter Replacement
25	715531	1	Decal, Danger
26	715532	1	Decal, Not for Vapor Recovery

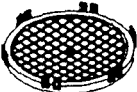
TOOLS AND ACCESSORIES

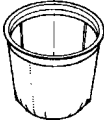
		Part No.	Description
A		OPTIONAL 800083 133249 800084	3" Rd Dust Brush Complete Dust Brush HSG 3" Bristle Insert 3"
B		800035	12" Crev Tool Complete
C		290000	Wand Assy 1-1/2", Complete
D		800317	Hose Assy. 1-1/2" x 10'
E		601032 808397 17916	11" Floor Tool, Complete Nozzle Floor Brush Replacement
F		800124	5" Tool Only Without Insert
G		760598PKG	Disposable Paper Replacement Debris Filter Bags Package of 10
H		110005PKG	Impact Pre-Filter Assembly
I		805038PKG	Disposable Paper Filter Protectors Package of 10
J		802215PKG	Plastic Bags Plain Brown, 2 mil. Package of 10
K		805058	Cloth Bag Complete

LIMITED WARRANTY

Minuteman International, Inc. warrants to the original purchaser/user that this product is free from defects in workmanship and materials under normal use and service for a period of two years from date of purchase. In addition, Minuteman International, Inc. will, at its option, honor labor warranty claims for the first 12 months from date of sale, provided such claims are submitted through and approved by factory authorized repair stations. Minuteman International, Inc. will, at its option, repair or replace without charge, except for transportation costs, parts that fail under normal use and service when operated and maintained in accordance with the applicable operation and instruction manuals.

This warranty does not apply to normal wear, or to items whose life is dependent on their use and care, such as belts, cords, switches, hoses, rubber parts, electrical motor components or adjustments. Parts not manufactured by Minuteman International, Inc. such as engines, batteries, battery chargers, hydraulic pumps, and tires are covered by and subject to the warranties and/or guarantees of their manufacturers. Please contact Minuteman International, Inc. for procedures in warranty claims against these manufacturers.

Special warning to purchaser — Use of replacement filters and/or prefilters not manufactured by Minuteman International, Inc. or its designated licensees, will void all warranties expressed or implied.

A potential health hazard exists without exact original equipment replacement.

All warranted items become the sole property of Minuteman International, Inc. or its original manufacturer, whichever the case may be.

Minuteman International, Inc. disclaims any implied warranty, including the warranty of merchantability and the warranty of fitness for a particular purpose. Minuteman International, Inc. assumes no responsibility for any special, incidental or consequential damages.

This limited warranty is applicable only in the U.S.A. and Canada, and is extended only to the original user/purchaser of this product. Customers outside the U.S.A. and Canada should contact their local distributor for export warranty policies. Minuteman International, Inc. is not responsible for costs or repairs performed by persons other than those specifically authorized by Minuteman International, Inc. This warranty does not apply to damage from transportation, alterations by unauthorized persons, misuse or abuse of the equipment, use of non-compatible chemicals, or damage to property, or loss of income due to malfunctions of the product.

If a difficulty develops with this machine, you should contact the dealer from whom it was purchased.

This warranty gives you specific legal rights, and you may have other rights which vary from state to state. Some states do not allow the exclusion or limitation of special, incidental or consequential damages, or limitations on how long an implied warranty lasts, so the above exclusions and limitations may not apply to you.

Minuteman[®]

World Headquarters
Minuteman International, Inc.
111 South Rohlwing Road
Addison, Illinois 60101

Minuteman Canada, Inc.
2210 Drew Road
Mississauga, Ontario
L5S 1B1

(630) 627-6900
FAX (630) 627-1130

(905) 673-3222
FAX (905) 673-5161

987209-1
Printed in U.S.A.